

LEAK-PROOF & WEATHER-TIGHT WALL BOXES

All Reversomatic wall boxes are made from corrosion resistance satin coat steel. The leak proof wall boxes are unpainted where the weather-tight wall boxes are epoxy painted - single coat to the interior & double coat to the exterior. The weather-tight wall boxes are tested and approved to ASTM E331-00 (Static Test) and ASTM E547-00 (Cyclic Static Test) standards.

REPLACES WALL CAPS AND BRICK VENTS

Model: WBL/WBW-8



Housing is made of heavy gauge satin coat galvanized metal which does not support corrosion

Extruded aluminum weather proof louvre. Mill finish

Stamped Leak-Proof Grille

Sloped from top to bottom creating a gravity effect on the Neoprene damper

Sloped from back to front, allows instant drainage when severe windy rainfall occurs

- Available:**
- SINGLE
 - DOUBLE
 - TRIPLE

- Optional:**
- Extruded Aluminum Louvered Grille
 - Painted Louver
 - Louver Less Flange
 - Custom Sizes

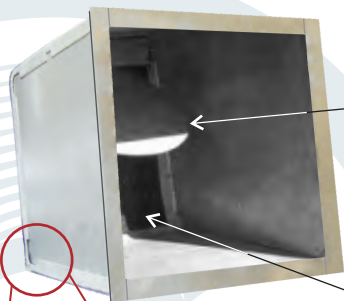

Damper Support Plate holds damper in place avoiding unnecessary flapping

Water resistant Neoprene Damper eliminates noisy clatter

Leak Proof Seamless Flanged Wrap Construction

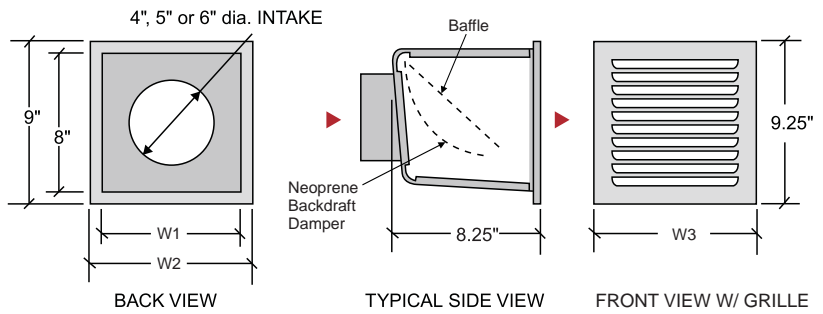

NOTE:
CAULKING - 3 sides only not on bottom (if caulking all 4 sides, must have draining holes)

TYPE	W1	W2	W3
Single Wall Box	8"	9"	9.25"
Double Wall Box	16"	17"	17.5"
Triple Wall Box	24"	25"	25.5"

EXTRUDED ALUMINUM GRILLES

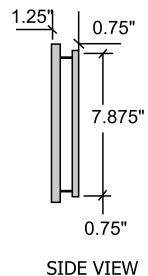
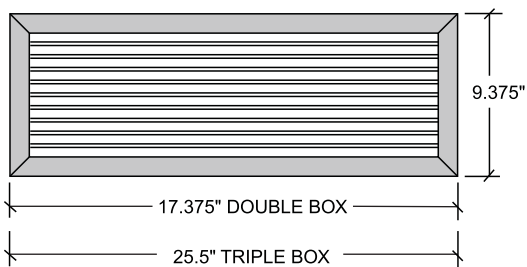
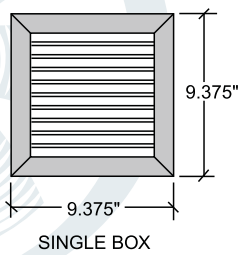

LEAK-PROOF & WEATHER-TIGHT WALL BOXES

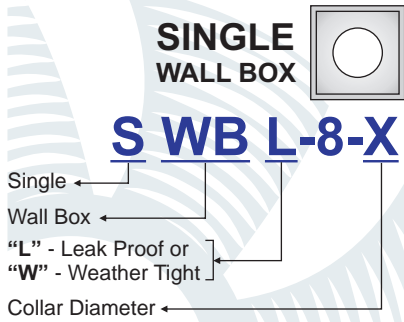

EXAMPLE:

SWBL-8-4
SWBL-8" (depth) -4" (dia.)

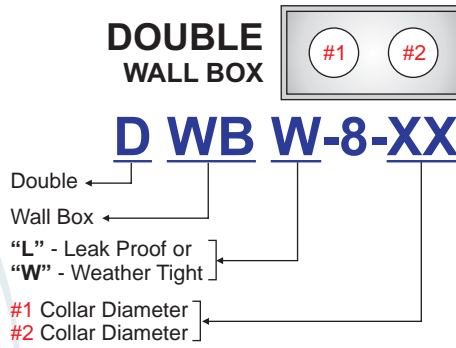

EXAMPLE:

DWBW-8-45
DWBW-8" (depth) -(#1) 4" dia. -(#2) 5" dia.

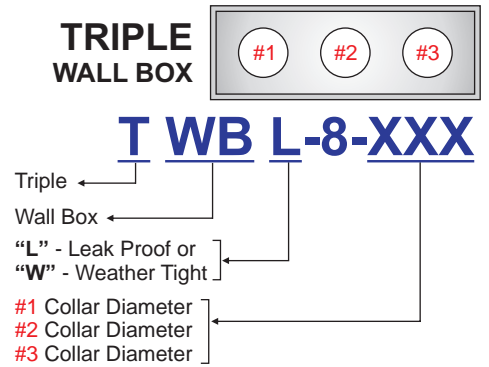

EXAMPLE:

TWBL-8-645
TWBL-8" (depth) -(#1) 6" dia. -(#2) 4" dia. -(#3) 5" dia.

IMPORTANT NOTE: Always count the number of collars from left to right, as you are looking into louvre side

STANDARD WALL BOX

The housing is constructed of heavy GA. galvanized satin coated metal. The WB30, WB40, WB50, WB60, WB70, WB80 models incorporate a closed cell neoprene damper, where as the WB124, WB185, WB246 are built of a light weight aluminum damper with gasketing at the bottom edge to eliminate clattering. All WB Wall Boxes come with standard aluminum stamped louvre grille or mill finish extruded aluminum louvre grille which can be painted to the colour of your choice at a modest cost.

Extruded Aluminum Grille

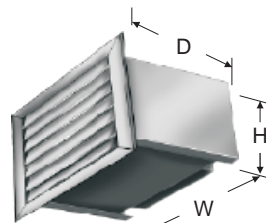
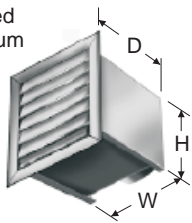

Stamped Standard Grille

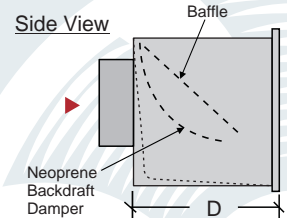
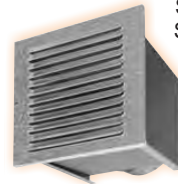

*12" deep available upon request

MODEL	INLET dia.	W	D	H
WB30	3"	8"	8"	8"
WB40	4"	8"	8"	8"
WB50	5"	8"	8"	8"
WB60	6"	8"	8"	8"
WB70	7"	9"	8"	9"
WB80	8"	10"	8"	10"

*Available in double, triple and custom sizes, contact factory.

MODEL	INLET opening	W	D	H
WB124	12" x 4"	16"	8"	8"
WB185	18" x 5"	24"	8"	8"
WB246	24" x 6 1/2"	30 5/8"	8"	9 7/8"
WB286	28 1/2" x 6 1/2"	30 5/8"	8"	9 7/8"

EXTRUDED ALUMINUM GRILLES

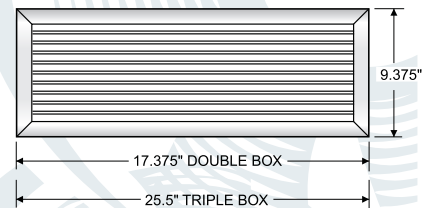
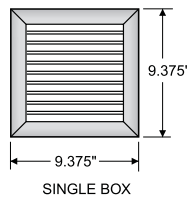

SOFFIT & JR. WALL BOX

*For Double, Triple and Custom sizes, contact factory.

